

LAIZESKĚ

Wireless Transmission System

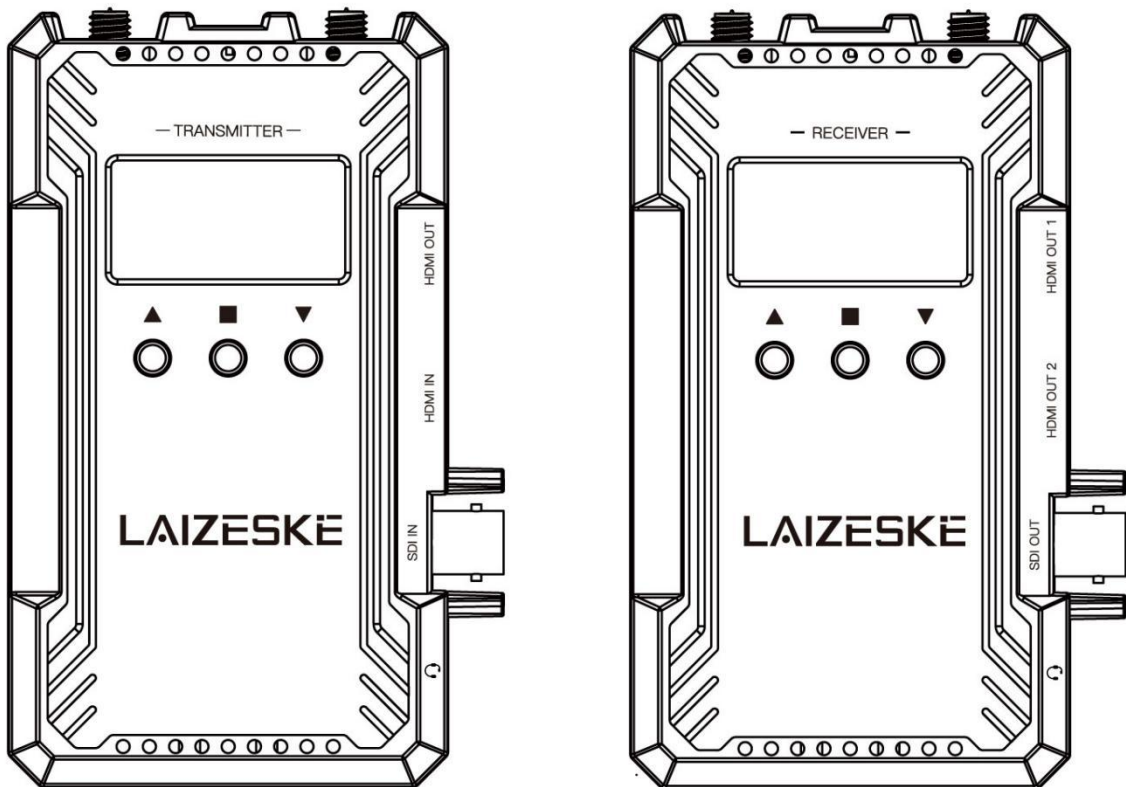

User Manual

Foreword

Thank you for purchasing LAIZESKE wireless video transmission system. Please read this manual carefully before using the product, wish you a happy experience!

■ Caution

Do not expose this device to extreme hot, cold, dusty or humid environments.

Do not scratch the device with sharp objects.

Do not drop this device from high place, as this may cause hardware damage.

This device is designed for non-water proofing. Please do not allow any liquid to penetrate into the device.

Do not attempt dismantle, open or repair this device by non-technical person, as this may cause permanent damage to the device.

■ Features

Dual HDMI & SDI (optional) signal interfaces

Transmission range up to 1000ft, with ultra-low latency 0.08S

Up to 1080P60Hz

With type-C to Ethernet adapter accessory, achieve live streaming

The transmitter can be switched as a receiver at will.

Wireless full-duplex talkback, real-time intercom between the director and the photographer.

One TX to multiple RX

Support APP monitoring for Android/IOS system.

13 frequency channels, AUTO channel scan.

Content

Installation Instruction-----	3
Port Instruction-----	4
UI Instruction-----	6
Streaming Instruction-----	11
APP Operation Instruction-----	12
Parameter-----	15
Frequency Chart-----	16

Installation Instruction

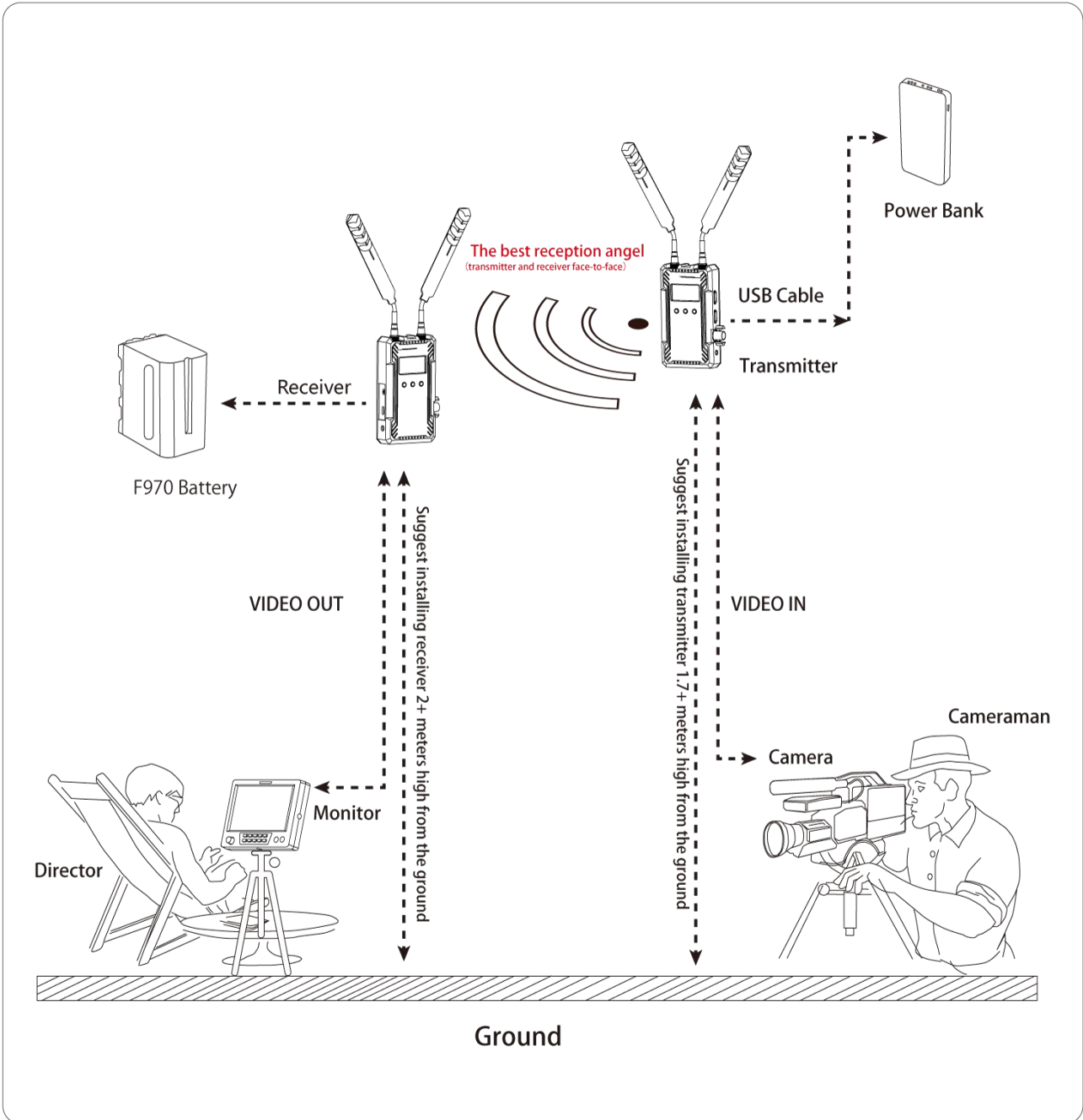

Port Instruction

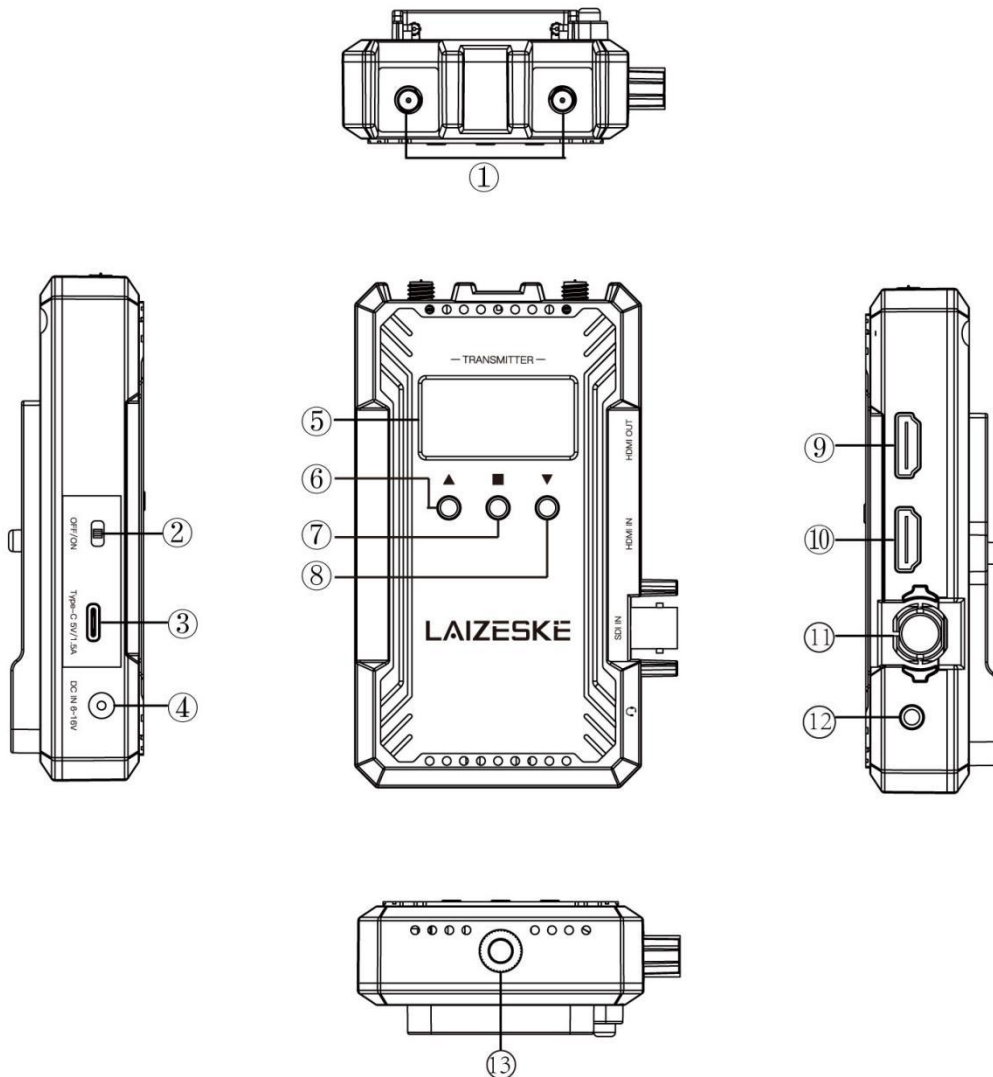

Transmitter

- ①: Antenna Ports
- ②: Power OFF/ON
- ③: Type-C Power Input/Upgrade
- ④: DC Power IN
- ⑤: OLED Screen
- ⑥: UP button
- ⑦: OK button
- ⑧: DOWN button
- ⑨: HDMI Signal Output
- ⑩: HDMI Signal Input
- ⑪: SDI Signal Input (optional)
- ⑫: 3.5mm Earphone Port
- ⑬: 1/4 Screw Hole

Port Instruction

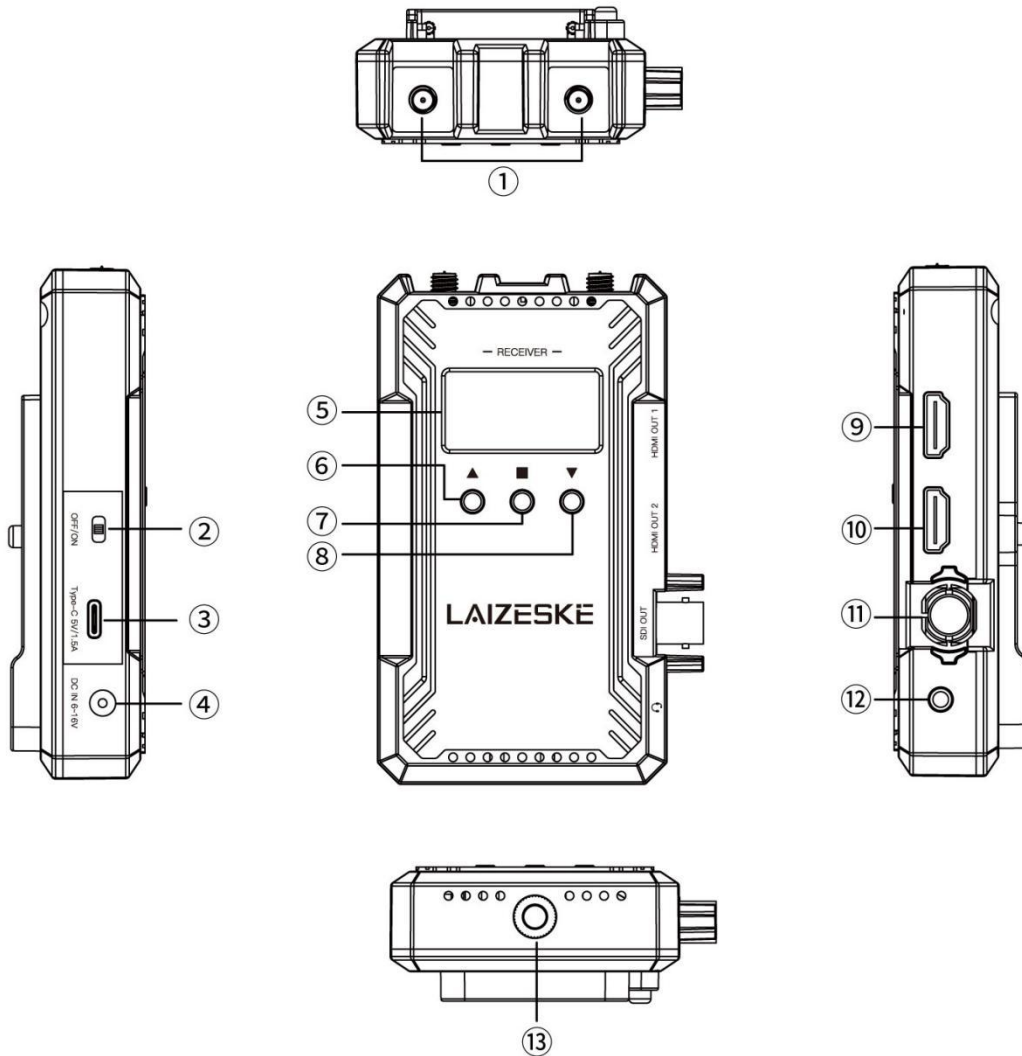

Receiver

- ①: Antenna Ports
- ②: Power OFF/ON
- ③: Type-C Power Input/Upgrade
- ④: DC Power IN
- ⑤: OLED Screen
- ⑥: UP button
- ⑦: OK/MENU button
- ⑧: DOWN button
- ⑨: HDMI Signal Output1
- ⑩: HDMI Signal Output2
- ⑪: SDI Signal Output(optional)
- ⑫: 3.5mm Earphone Port
- ⑬: 1/4 Screw Hole

UI Instruction

1. Startup

The startup screen is as above. When the device runs, the main menu will display.

2. Main Menu

Main menu including channel, device type(TX/RX), link status, signal strength, video format, intercom mode, battery level, temperature, fan status, etc. information.

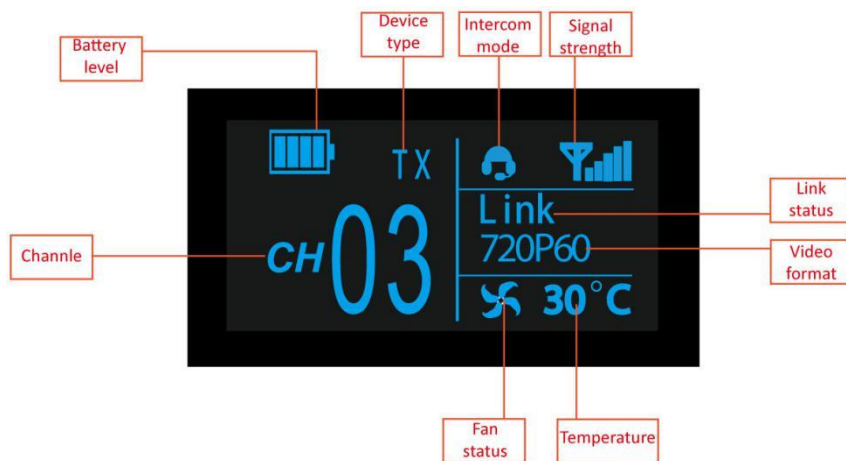

- 1) Channel switch: press“△”or“▽”to change channels. Press“□”to confirm the channel.
- 2) Long press“△”on the transmitter, the screen will display device name and password. Long press“△”on the receiver, the screen will also display device name and password if it is connected to transmitter.

3. Secondary Menu

Long press“□”for 2 seconds to enter into the secondary menu.

Long press“□”for 2 seconds again to back to the secondary menu.

Press“△”or“▽”to switch the options in secondary menu and press“□”to confirm selection.

UI Instruction

Device (transmitter only): device type

Switch TX (transmitter) and RX (receiver) manually.

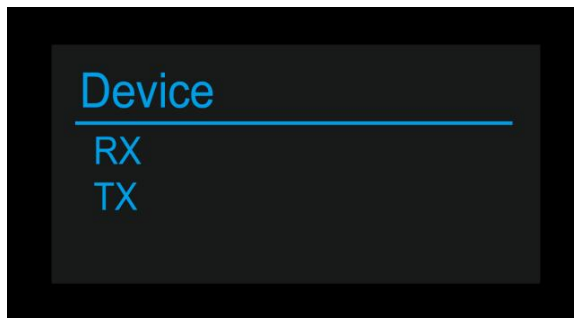

Source (transmitter with SDI port only): signal source

Switch the signal source between HDMI and SDI on transmitter. SDI input is selected by default if both HDMI and SDI sources are connected.

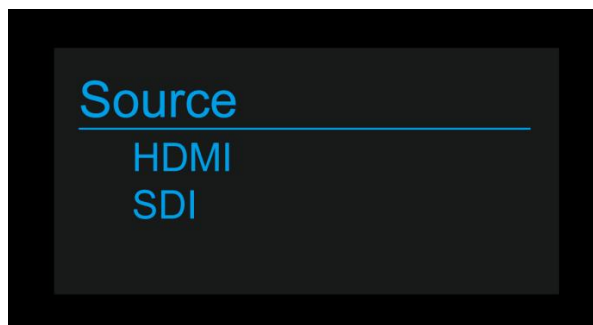

FAN status

Turn on or off the fan manually

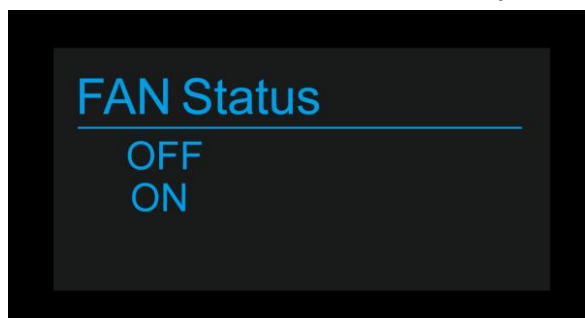

UI Instruction

Intercom

Switch between Full Duplex, TD mode(TD speak, Cameraman listen), OFF(turn off intercom)

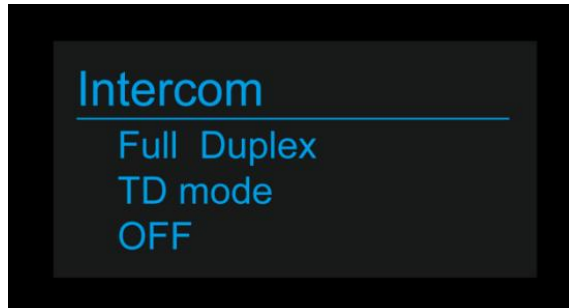

WPS: pairing

To pair transmitter and receiver. One Transmitter allows to pair 4 receiver maximum. Turning on WPS both for transmitter and receiver at the same time, then turn off the receive which finished pairing. Using the same pairing method to add next one receiver. Last, turning on all of the paired devices.

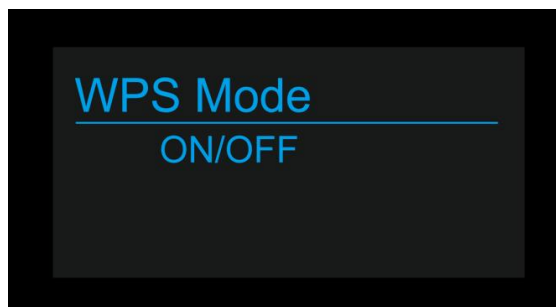

Priority

Choose high image quality prior or low latency prior.

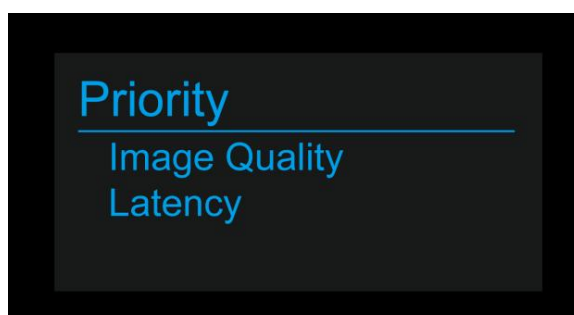

UI Instruction

WIFI_SSDI

Showing device name and password



Version

Showing the device's version number

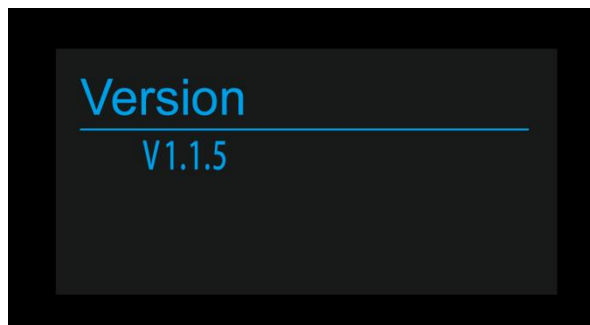

Web

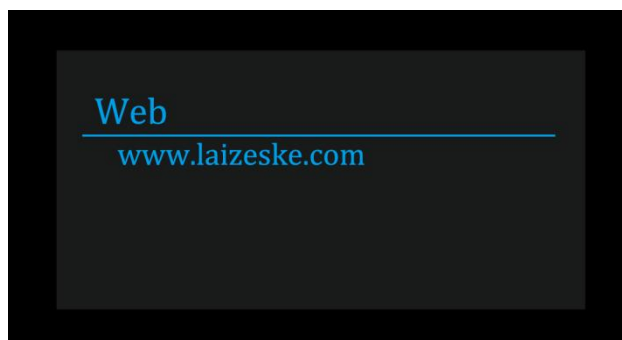

UI Instruction

Telephone

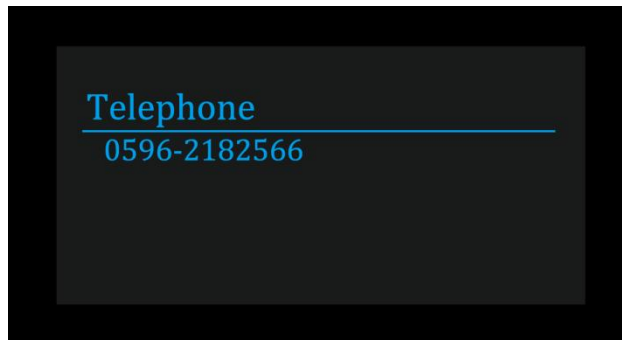

Language

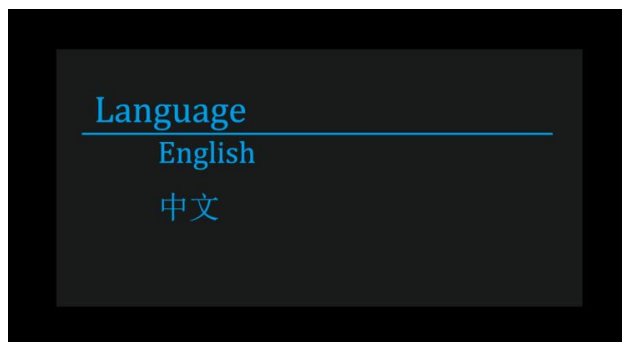

IP: IP address (only the receiver has this menu)

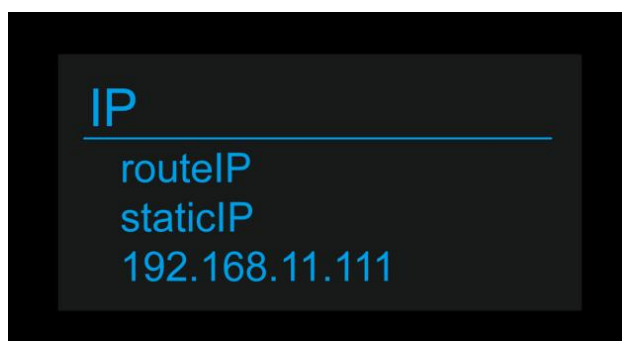

Streaming Instruction

After the receiver links to transmitter and receives the video, plug the Type-C to Ethernet adapter to receiver's Type-C port. The Type-C to Ethernet adapter will flash red light.

Static IP setting

1. The receiver's default mode is static IP. It can be selected in the secondary menu IP->staticIP

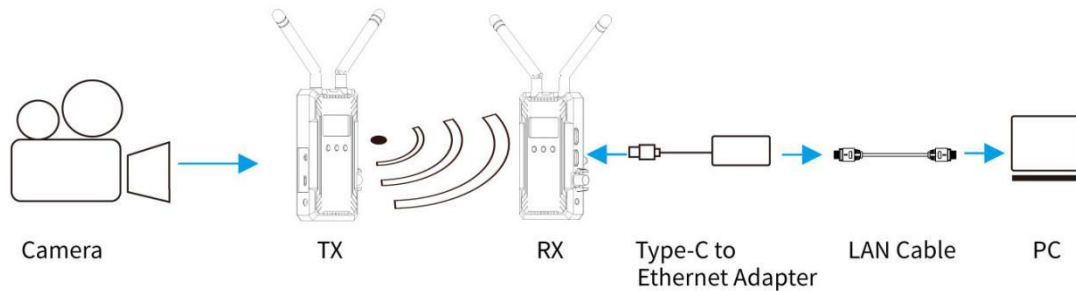

2. As the picture shown above, connect the Type-C to Ethernet adapter with computer via LAN cable.

3. The receiver's static IP address is 192.168.11.111. It can be found on the receiver's secondary menu. The computer also has to be set to static IP. Set the computer's static IP to be 192.168.11.xxx, xxx can be replaced by any number between 2 and 254 not include 111. After the settings completed, run CMD->ping 192.168.11.111 on computer to check if it works.

4. Use the URL <rtsp://192.168.11.111:554/test.264> on up streaming software such as VLC or OBS.

RouteIP setting

1. Enter into the secondary menu on the receiver's IP. Then select routeIP

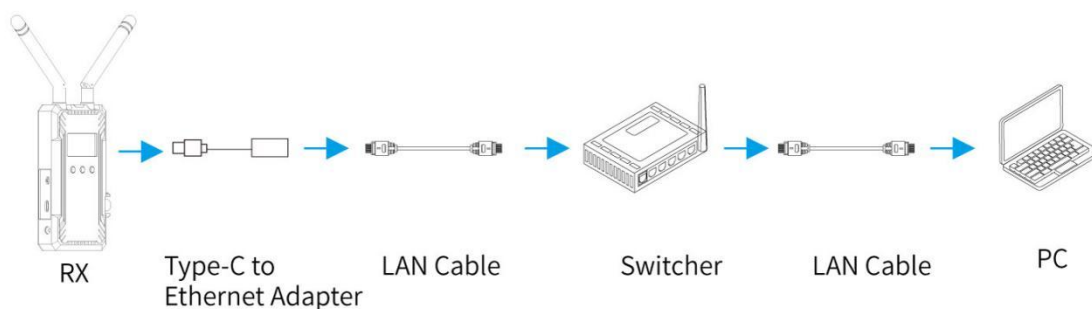

2. Connect a monitor to the receiver. Then connect the receiver to the router via the Type-C to Ethernet adapter. If the blue light flashes on the adapter, it indicates that the connection is good. The monitor will show the IP address on the left bottom.

3. Connect the computer to the router. Push streaming with the url: <rtsp://IP address shown on the monitor/test.264>

APP Operation Instruction

1. APP Download

iOS APP Download

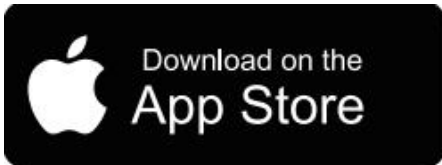

iOS user search "LAIZESKE"
(APP Name:MMonitor)

Android APP Download (APP Name: LAIZESKE)



Search "LAIZESKE" on Google Play to get



Scan the QR code to download

2. Connect smart devices to transmitter

After the transmitter is powered on, go to Setting-Wireless & networks on smartphone/tablet, select the transmitter's name and input the password to connect the devices. Please find the transmitter's name and initial password as below. Then go to APP home page and click "Video" to monitor.

APP Operation Instruction

(Note: No need to input password again if it was saved on smart phone/tablet)

Device name: LAIZESEK_5G_XXXXX

Password: 12345678

3. APP Operation (e.g. Android System)

a. Click “Video” on home page to enter into monitoring mode.

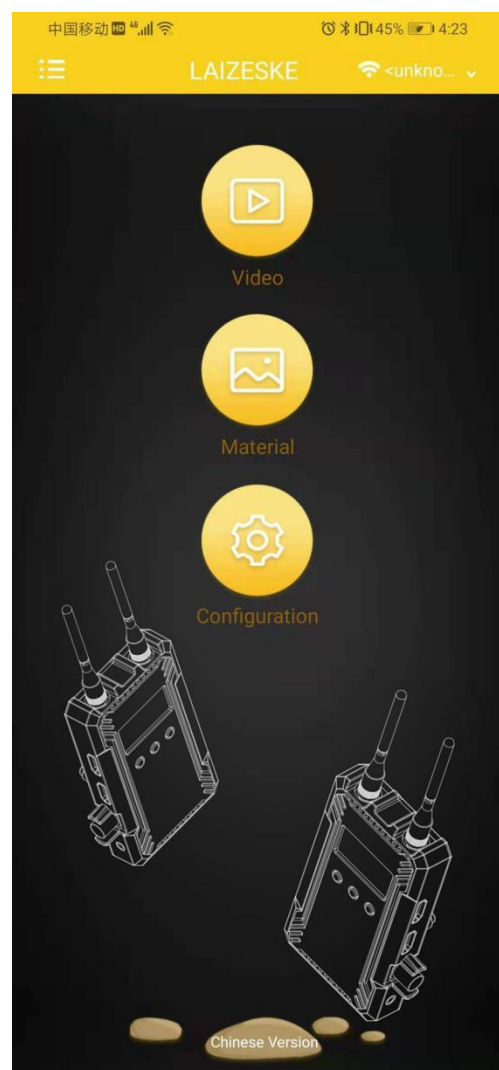

b. Click “√” at the bottom of screen. It will show SAVE IMAGE, RECORD (only available for Android at present), MATERIAL, CONFIGURATION.

APP Operation Instruction

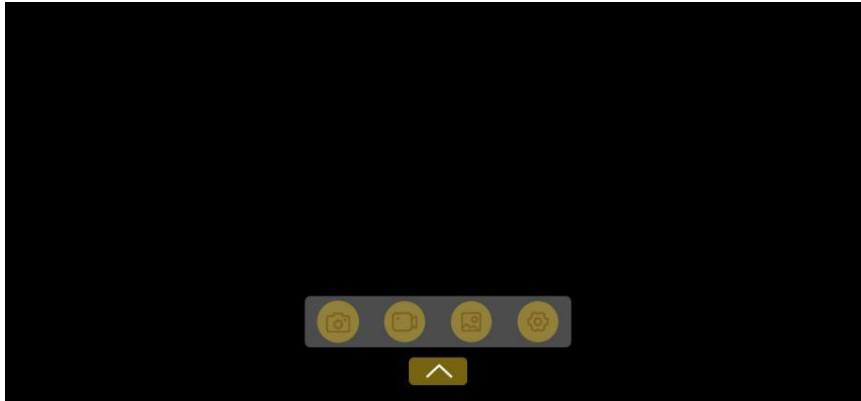

Long press the screen to show up the professional monitoring menu.

Monochrome, False Color, Center Marker are available at present, more features are developing.

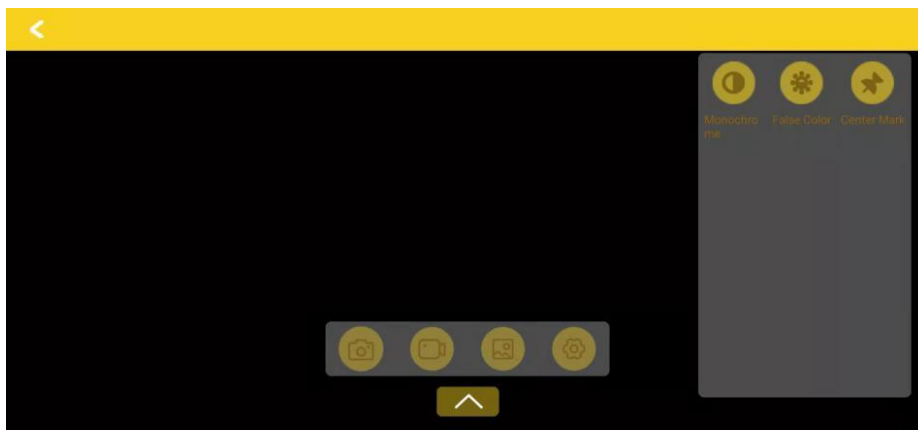

- c. Click “Material”to check the images and videos saved on smartphone/tablet.
- d. Click “ Configuration”to access configuration screen.
- e. Click 英文版/Chinese Version at the bottom of home page to change language.

Parameter

	Transmitter	Receiver
Screen	OLED	OLED
Interface	1 * SDI input (optional) 1 * HDMI input, 1* HDMI output 2 *Antenna port (RP-SMA Male) DC power input, 3.5mm headphone jack , Type-C	2* HDMI output 1* SDI output (optional) 2 *Antenna port (RP-SMA Male) DC power input, 3.5mm headphone jack, Type-C
Power Supply Way/Voltage Range	F970 battery , Type-C: 5V/1.5A DC adapter: 6-16V Note: Due to the actual output of some batteries will be greater than 16V, it may burn out. Please make sure that the actual output voltage of the battery used is less than 16V.	F970 battery , Type-C: 5V/1.5A DC adapter: 6-16V Note: Due to the actual output of some batteries will be greater than 16V, it may burn out. Please make sure that the actual output voltage of the battery used is less than 16V.
Power Consumption	<7.5W	<6.5W
HDMI Input/Output Video Format	480P60, 576P60 720P60/59.94/50 1080P60/59.94/50/30/29.97/25 /24/23.98 1080i60/59.94/50 HDMI Type A	480P60, 576P60 720P60/59.94/50 1080P60/59.94/50/30/29.97/25 /24/23.98 1080i60/59.94/50 HDMI Type A
SDI Input/Output Video Format	480P60, 576P60 720P60/59.94/50 1080P60/59.94/50/30/29.97/25/24/ 23.98 1080i60/59.94/50 1*BNC	480P60, 576P60 720P60/59.94/50 1080P60/59.94/50/30/29.97/25/24/ 23.98 1080i60/59.94/50 1*BNC
Frequency	5.1-5.9GHz	5.1-5.9GHz
Modulation Mode	OFDM	OFDM
Transmission Power	Maximum 17dBm	/
Receiving Sensitivity	/	-87dBm
Band Width	20MHZ	20MHZ
Latency	Min0.08S	Min0.08S
Intercom Frequency Response Range	20Hz~20KHz	20Hz~20KHz
Operating Temperature	0°C ~ 40°C	0°C ~ 40°C
Storage Temperature	-20°C ~ 60°C	-20°C ~ 60°C
Unit Size(mm)	67L*24W*118H (excluding antenna)	67L*24W*118H (excluding antenna)
Unit Weight	128g	128g

Frequency Chart

Device Channel	WiFi Channel	Frequency/MHz
1	36	5180
2	38	5190
3	40	5200
4	44	5220
5	46	5230
6	48	5240
7	149	5745
8	153	5765
9	155	5775
10	157	5785
11	159	5795
12	161	5805
13	165	5825

Common Problem

1. The screen appears mosaic or the signal connection is unstable
It means that there is a WIFI signal close to the transmission frequency, you can re-select another channel. (Note: only the receiver is allowed to adjust the channel)
2. When the transmitter and receiver cannot be connected.
Please turn off the transmitter and receiver, then turn them on again at the same time, and turn on the WPS mode to pair again.
3. When signal frequency is weak
Please try to choose another channel with a wider frequency span. (For instance, the signal of channel 10 is weak, please choose channel 1 or 6, but not channel 9 or channel 11).
4. The poor WIFI reception of the mobile phone
It is related to the brand and model of the mobile phone. Please try different mobile phones.

★ As we are improving product features and product performance, so if there is any change on the specification without prior notice.